

Motoreductores a Engranajes Coaxiales - Línea FR

CATALOGO TECNICO



ALFA

Transmisiones Industriales

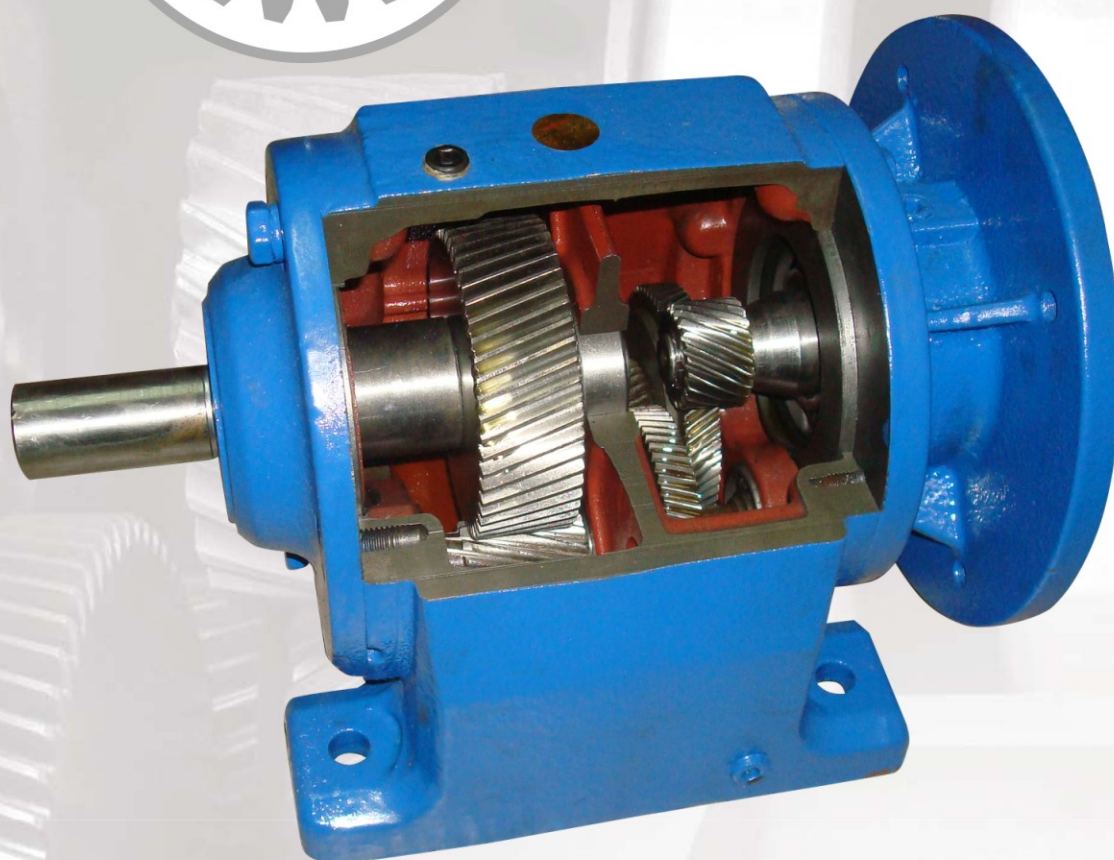

ISO 9001

Características Técnicas

- Engranajes fabricados en aceros de cementación, cementados y con flanco de diente rectificado.
- Caja de fundición de hierro con nervaduras interiores.
- Piñón de entrada autoportado para montaje directo de motores normalizados IEC.
- Bajo nivel del ruido.
- Rodamientos ampliamente dimensionados.
- Sellado con retenes de doble labio y anillos o ring en todas las tapas y bridas.
- Amplia gama de relaciones de transmisión disponibles.

Entrega inmediata.



Dimensiones Generales

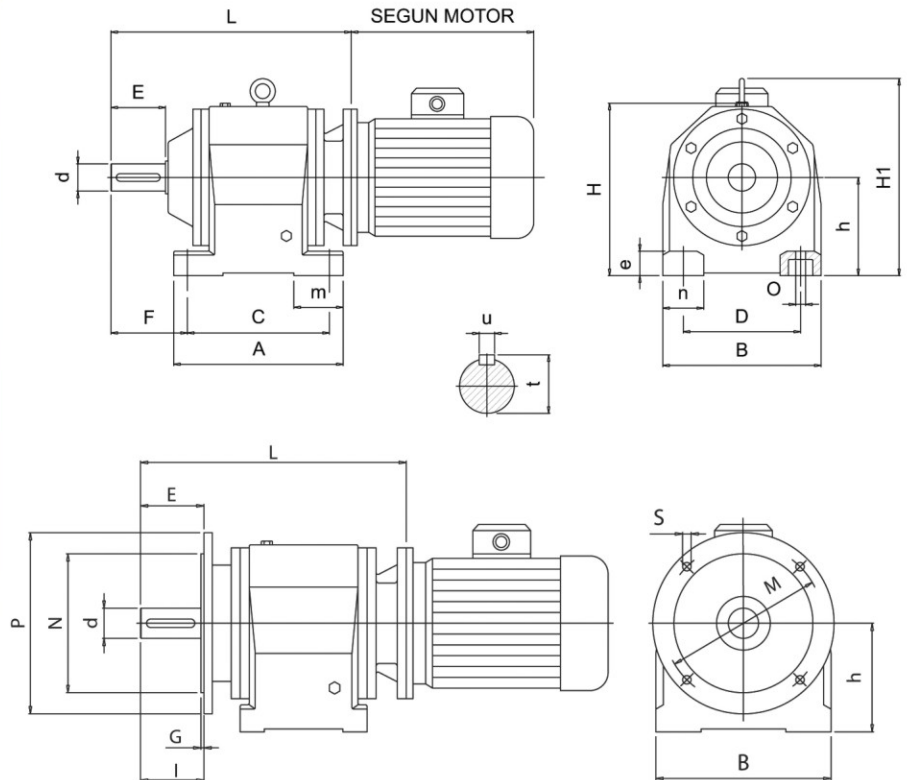

Modelo	A	B	C	D	d	Tol.	E	e	F	G	h	H
FR-32	110	135	85	110	20	ISO k6	40	12	58	3	75	141
FR-42	160	145	130	110	25	ISO k6	50	20	75	3.5	90	165
FR-43												
FR-62	200	190	165	135	30	ISO k6	60	25	90	3.5	115	206
FR-63												
FR-72	245	230	205	170	40	ISO k6	80	30	115	4	140	251
FR-73												
FR-82	310	290	260	215	50	ISO k6	100	45	140	5	180	316
FR-83												
FR-92	365	340	310	250	60	ISO m6	120	55	160	5	225	386
FR-93												
FR-102	440	400	370	290	70	ISO m6	140	65	185	5	250	437
FR-103												

Modelo	H1	I	L	O	P	M	N	S	m	n	u	t
FR-32	-	40	197.5	10	120	100	80	6.6	-	25	6	22.5
FR-42	-	50	262	9	200	165	130	11	40	35	8	28
FR-43												
FR-62	-	60	314	14	250	215	180	14	60	55	8	33
FR-63												
FR-72	287	80	385	18	300	265	230	14	70	60	12	43
FR-73												
FR-82	361	100	490	18	350	300	250	18	90	75	14	53.5
FR-83												
FR-92	431	120	555	22	450	400	350	18	100	90	18	64
FR-93												
FR-102	500	140	627	26	450	400	350	18	125	110	20	74.5
FR-103												

Tol: Tolerancias Ejes de Salida : d ≤ 50mm ---- ISO k6
> 50mm ---- ISO m6

Tabla De Potencias Nominales (HP)

Modelo	Relación Nominal								
	5	7.5	10	12.5	15	20	25	30	40
FR-32	-	0.5	0.5	-	0.5	0.5	0.5	-	-
FR-42	4	3.5	2.6	2.5					
FR-43					2	1.5	1.2	1	0.75
FR-62	7.5	7.5	6.2	5.5	4				
FR-63						3.5	2.6	2.3	1.8
FR-72	15	12.5	10	9	7	6			
FR-73							4.6	4	3
FR-82	24	20	22	19	15	12			
FR-83							10	8	6
FR-92	50	43	36	34	30				
FR-93						24	20	17	12
FR-102	75	70	62	33	53				
FR-103						40	33	28	20

Nota: Las potencias están indicadas en Hp
Los valores indicados son para motor normalizado de 1500 rpm.

Tabla de Relaciones Exactas

Modelo	Relación Nominal								
	5	7.5	10	12.5	15	20	25	30	40
FR-32	-	8.07	9.37	-	15.28	20.84	24.33	-	-
FR-42	5.43	7.27	10.92	12.01					
FR-43					14.36	19.15	24.46	33.41	41.97
FR-62	5.16	7.99	10.82	12.25	15.95				
FR-63						19.68	26.64	30.16	39.27
FR-72	5.15	7.36	9.69	12.17	15.98	20.16			
FR-73							26.06	29.89	38.43
FR-82	5.04	7.03	10.22	11.51	14.69	19.64			
FR-83							24.52	28.77	39.95
FR-92	5.82	6.94	9.37	13.01	14.75				
FR-93						19.57	23.82	27.33	39.70
FR-102	5.53	7.27	9.05	25.18	14.02				
FR-103						20.78	25.18	30.05	40.59

Dimensiones de Motores IEC normalizados

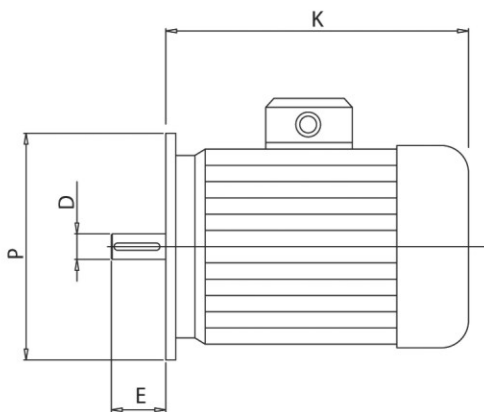

Carcasa	63	71	80	90S	90L	100L
D	11	14	19	24	24	28
E	23	3	40	50	20	60
K(*)	177	211	234	251	276	306
P	140	160	200	200	200	250

Carcasa	112	132S	132M	160M	160L	180
D	28	38	38	42	42	48
E	60	80	80	110	110	110
K(*)	328	374	411	479	523	602
P	250	300	300	350	350	350

(*) Varía según la marca de motor).

Posiciones de Montaje

B3

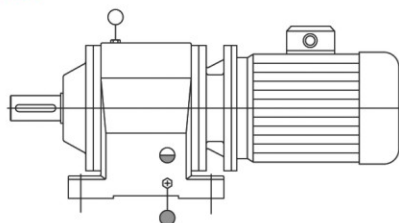

B8

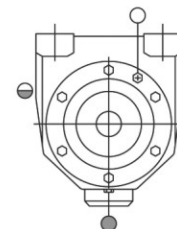

B6

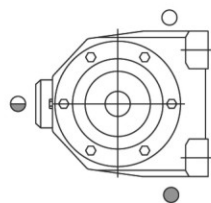

B7

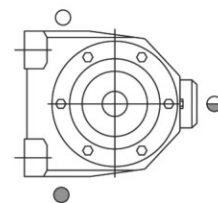

V1

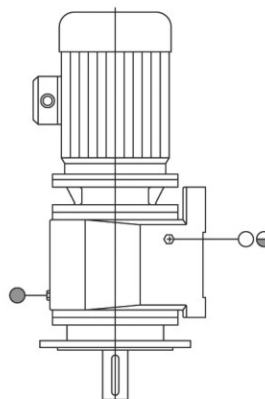

V3

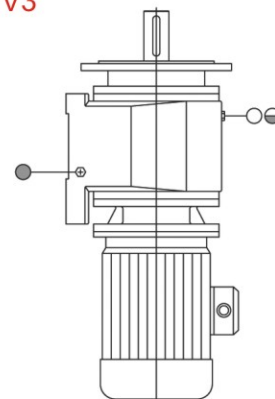

Disponible también en formato reductor con eje de entrada

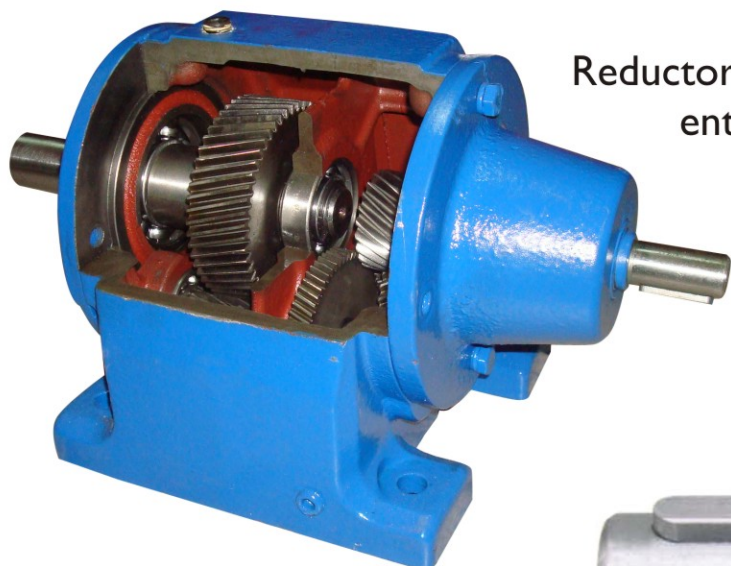

Reductor con eje de entrada sólido



Lubricantes Recomendados

Aplicación	Tipo de Lubricación	Temperatura Ambiente °C	ISO viscosidad	Mobil	Shell
Reductores a Engranaje	Aceites	+40 a 0	VG 220	Mobilgear 630	Omala Oil 220
		+25 a -15	VG 150 VG 100	Mobilgear 629	Omala Oil 100
		+10 a -30	VG 68-46 VG 32	Mobil D.T.E. 15M	Tellus Oil T32
		-20 a -50	VG 22 VG 15	Mobil D.T.E. 11M	Aero Shell Fluid 41
	Grasa	+40 a -15		Mobilpex 44	Grease S 3655
	Especiales	-40 a +80	VG 220	Mobil SHC 630	
-40 a +10		VG 32	Mobil SHC 624		



Av. Pte. Perón (Ex Kennedy) 2811 - San Justo (1754) Buenos Aires Argentina

Tel/fax: 4651-5008 / 4484-1705

E-mail: info@transmisionesalfa.com.ar

alfa_transmisiones@hotmail.com

www.transmisionesalfa.com.ar